

# METALMASTER

## PLATE ROLLS OPERATION MANUAL



### Models.

PR-133A - 1300 x 2.5mm (S802)

PR-134A - 1300 x 4.0mm (S803)

PR-136A - 1300 x 6.5mm (S804)

PR-204A - 2000 x 4.0mm (S805)

PR-252A - 2550 x 2.5mm (S806)

*Edition No* : MPR-002

*Date of Issue* : 7/2018

[www.machineryhouse.com.au](http://www.machineryhouse.com.au)



# OPERATION MANUAL

## MACHINE DETAILS

<b>MACHINE</b>	<input type="text" value="MECHANICAL PLATE ROLLS"/>
<b>MODEL NO.</b>	<input type="text"/>
<b>SERIAL NO.</b>	<input type="text"/>
<b>DATE OF MANF.</b>	<input type="text"/>

Distributed by



[www.machineryhouse.com.au](http://www.machineryhouse.com.au)

[www.machineryhouse.co.nz](http://www.machineryhouse.co.nz)

**Note:**  
 This manual is only for your reference. Owing to the continuous improvement of the METALMASTER machines, changes may be made at any time without obligation or notice. Please ensure the local voltage is the same as listed on the specification plate before operating this electric machine.



**NOTE:**  
 In order to see the type and model of the machine, please see the specification plate. Usually found on the back of the machine. See example (Fig.1)

<b>METALMASTER</b>	
PRODUCT SPECIFICATION	
MODEL:	<input type="text"/>
CAPACITY:	<input type="text"/>
SER. NO:	<input type="text"/>
MFG DATE:	<input type="text"/>
WEIGHT:	<input type="text"/>
VOLTS:	<input type="text"/>
MOTOR Kw:	<input type="text"/>
<a href="http://www.machineryhouse.com.au">www.machineryhouse.com.au</a>	
Made in China	

Fig.1



## OPERATION MANUAL

### CONTENTS:

1. GENERAL MACHINE INFORMATION	
1.1 Specifications.....	4
1.2 Standard Equipment.....	4
2. IMPORTANT INFORMATION	
2.1 Safety Requirements.....	5
2.2 Safety Features of the Machine.....	7
2.3 Lifting Instructions.....	8
3. INSTALLATION	
3.1 Base Foundation and Securing Points.....	9
3.2 Machine Leveling.....	10
3.3 Checking the Power Supply.....	10
4. COMMISSIONING	
4.1 Preparation of the Machine.....	11
4.2 Commissioning Check List.....	11
5. OPERATION INSTRUCTION	
5.1 Safety Check Prior to Operating.....	12
5.2 Rolling.....	12
5.3 Releasing The Swinging Roller.....	13
5.4 Resetting The Zero Position.....	14
5.5 Resetting Wire Emergency Stop.....	14
6. MAINTAINANCE	
6.1 Lubrication Points.....	15
6.2 Adjusting The Safety Wire Switch.....	16
6.3 Adjusting Bending Roll Parallelism.....	17
6.3 Troubleshooting.....	18
SPARE PARTS.....	19



## OPERATION MANUAL

### 1.1 SPECIFICATION

Order Code	S802	S803	S804	S805	S806
MODEL	PR-133A	PR-134A	PR-136A	PR-204A	PR-252A
Max. Rolling Width	1300	1300	1300	2000	2550
Max Rolling thickness (Mild Steel)	2.5mm	4.0mm	6.5mm	4.0mm	2.5mm
Rolling diameter	90mm	120mm	150mm	150mm	150mm
Rotate speed	12 RPM	10 RPM	7 RPM	7 RPM	7 RPM
Motor Power	Main 1.1kw	Main 2.2kW	Main 2.2 kW	Main 2.2 kW	Main 2.2 kW
	Bending 1.1kW	Bending 1.1kW	Bending 1.5 kW	Bending 1.5 kW	Bending 1.5 kW
Voltage	415	415	415	415	415
Overall dimension	177x126x97cm	177x126x101cm	193x125x114cm	253x126x120cm	308x126x120cm
Weight	655 kgs	865 kgs	1330 kgs	1575 kgs	1830 kgs

#### **WARNING**

Do not attempt to roll any size profile having a greater thickness than the maximum rolling thickness specified for the capacity of the machine. Do not attempt to roll more than one piece at a time. Do not use the machine for any other job/application than the one for which it has been designed for.

#### **WARNING**

The rolls fitted to these models are not hardened and are designed for rolling mild steel plate. Attempting to roll stainless steel or hardened steel can cause damage to the machine and/or can score and cause damage to the rollers. Attempting to roll any material other than what the machine is designed for may void warranty.

### 1.2. STANDARD EQUIPMENT

- Tools
- Instruction Manual
- Foot switch and control panel

The above specifications were current at the time this manual was published, but because of our policy of continuous improvement, Metalmaster reserves the right to change specifications at any time and without prior notice, without incurring obligations.



## OPERATION MANUAL

### 2. IMPORTANT INFORMATION

#### 2.1 SAFETY REQUIREMENTS

The purpose of the safety section of this manual is to inform operators and maintenance personnel of the precautions to be taken while operating or servicing the machine. The following are a few basic guidelines to follow, but as with any type of machinery good judgment and a safe attitude should be applied at all times.



Safety glasses must be worn at all times in work areas. Earmuffs should be worn if the work area is noisy.



Sturdy footwear must be worn at all times in work areas.



Gloves must be worn when handling the material.



Long and loose hair must be contained with a net or under a hat

#### SAFETY CHECKS BEFORE OPERATING

- Locate and ensure you are familiar with all machine operations and controls.
- Take notice of any warning labels on the machine and do not remove them.
- Ensure all guards are fitted, secure and functional.
- Ensure working parts are well lubricated and the rolls are free of rust and dirt.
- Check workspaces and walkways to ensure no slip/trip hazards are present
- Be aware of other people in the area. Ensure the area is clear before using equipment.

#### SAFETY CHECKS WHEN OPERATING

- Operate the machine only if all protective devices and guarding are mounted and effective.
- Remove any objects and tools that are in the way. Use only the equipment required to assist in the rolling of the material.
- Check that the material to be rolled is the correct thickness.
- Ensure the swing roller is secured before rolling
- Ensure your fingers and limbs are clear before operating the plate rolls
- Adjust the top roller slowly
- Check workpiece is secure.
- Keep clear of moving parts

#### POTENTIAL HAZARDS AND INJURIES

- Sharp edges and burrs.
- Squash/crush and pinch points.
- Impact from swing roller



## OPERATION MANUAL

### 2.1 SAFETY REQUIREMENTS Cont.

#### DO NOT

- Do not use faulty equipment. Immediately report suspect machinery.
- Do not use plate rolls for rolling metal that is beyond its capacity in thickness, or type.
- Do not attempt to roll rod, wire, strap or spring steel material
- Do not remove the safety cable around the machine under any circumstances while the machine is in an operational mode.
- Do not operate the machine without proper adjustment according to sheet thickness.
- Do not roll material which has been welded or deformed.
- Do not use the machine if the rolls are excessively damaged.

#### WHEN MAINTAINING THE MACHINE

- Isolate the machine completely before any repair work is carried out.
- Disconnect and tag the power supply if not required while doing maintenance
- The machine is to be serviced and/or be repaired only by the authorized personnel

#### PINCH POINT SAFETY WARNING

Machinery can pose a hazard with moving parts, conveyors, rollers and rotating shafts. Never reach into a moving machine. The machine must always be properly maintained. Always use the machine tool with the safety precautions provided with your equipment. They act as a barrier between the moving parts and your body.

In order to prevent accidents involving pinch points, the points listed below must be followed when using machinery

- Use the right tool for the job
- Identify possible pinch point hazards in your work area
- Concentrate on objects that move or are capable of moving.
- Ask yourself, "What will happen if this moves? Will I be in the path of that movement?"
- Be aware of pinch points created by objects that move and come into direct or close contact with fixed objects.
- Be on guard whenever you put your hands, fingers, toes, or feet "between" anything.
- Discuss and point out pinch point hazards as part of your risk assessment.
- Make sure your hands are placed where you can see them.





# OPERATION MANUAL

## 2.2. FEATURES OF THE MACHINE:

The electrical circuits of your machine are designed to allow operation with maximum safety. The following precautions are available on the machine for enhanced safety.

The Emergency stop button (engaging type) is found on the foot switch control unit. Once the button has been pressed to reset the emergency stop, the red button must be rotated to reset the stop.

### Foot pedal control

The foot pedals are used to activate the rolling direction

### EMERGENCY SAFETY STOP

This Metalmaster Rolling machine is fitted with a safety Emergency Stop in the form of a red wire that is around the machine. (Fig. 2.1) Pressing against this wire with any part of your body will cut the power to the machine. Safety signs have been placed around the machine to remind the operator of this Emergency Stop. (Fig. 2.2)

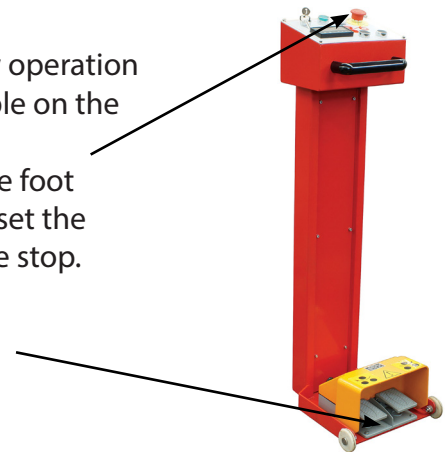

Fig. 2.1

Fig. 2.2



### Main Controls

The main machine operating controls are located on the mobile unit.

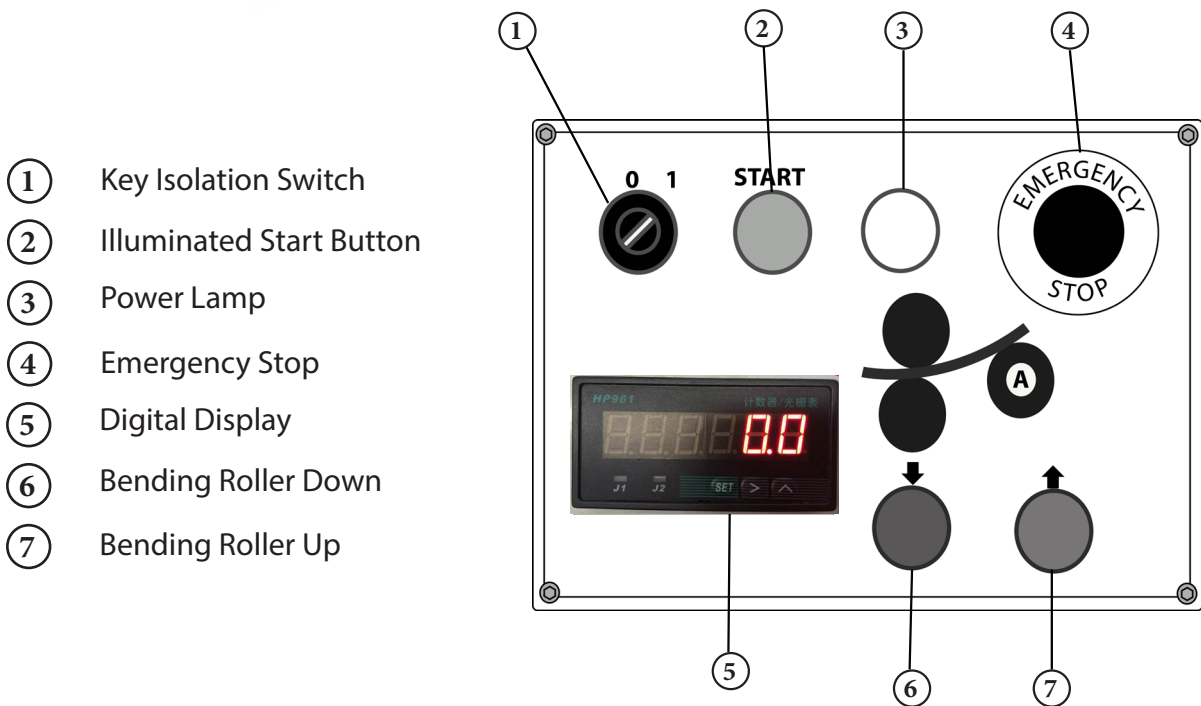



## OPERATION MANUAL

### 2.3 LIFTING INSTRUCTION

- The lifting device should be capable of lifting the weight of the machine.
- Before using the equipment inspect them to ensure that they are in good condition and are certified
- If using slings, they must be arranged correctly so the machine is lifted level.

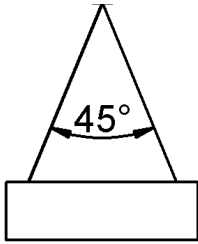

When the slings are at a 45° angle then each sling will be carrying the equivalent of 50% of load weight.

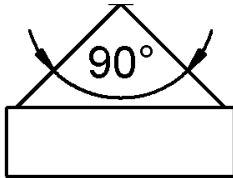

When the slings are at a 90° angle then each sling will be carrying the equivalent of 75% of the load weight on each sling.

**Note:** Metalmaster recommend not to exceed 90° angle

- The lifting device operator should be a qualified & trained person in rigging and lifting  
The machine can also be lifted with a forklift.



### WARNING

When lifting with a forklift observe the following

- The forklift's capacity is the maximum weight it can safely carry at a specified load center. Check the load capacity data plate on the forklift to ensure that the load does not exceed the capacity.
- The forklift operator must be licensed to operate the forklift
- Make sure the tynes of the forklift are protruding through the other side of the machine before lifting. (Fig 2.3)



Fig. 2.3

- Make sure that the load is level and will not slip off the tines





# OPERATION MANUAL

## 3. INSTALLATION

The machine must be leveled and firmly stationed on the floor where it is to be used, according to the Installation Diagram attached.

The floor load, where the machine is to be installed, must be suitable for the weight of the machine.

### 3.1 BASE FOUNDATION AND SECURING POINTS

Before securing the machine a solid concrete base must be prepared to the specification of the machine.

The sizes for the bolt holes position are listed as A-B. (Check with your dealer before the machine arrives) (Fig.3.1)

Fig. 3.1

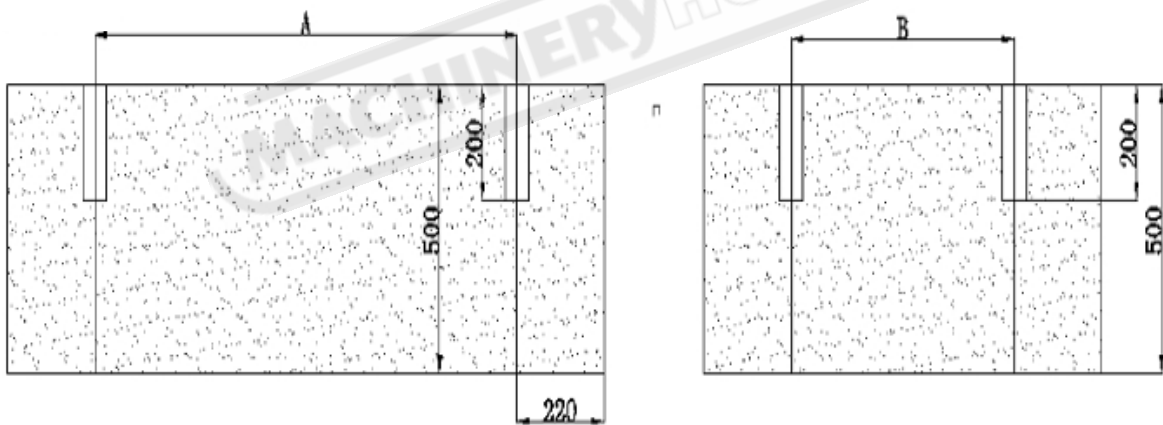

### 3.2 MACHINE LEVELING

To set your machine up so that it operates to optimum performance, apply the following procedure

After your plate rolls have been anchored to a concrete slab floor, it then needs to be leveled. The leveling is performed using each of the screws on each pad.(Fig. 3.2). Loosen the hold down bolts and place a level on the surface of the working table. Tolerances: 1000:0.30mm, for both axis.

Metal plates need to be placed under each jacking screw to distribute the load. Once level then tighten the hold down bolts.

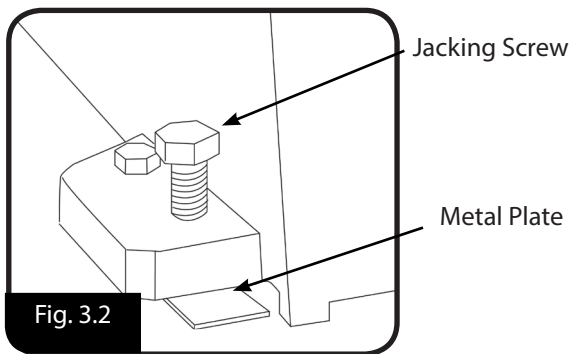

The machine must not rest on supports other than those defined in Fig. 3.2

### 3.3 CHECKING THE POWER SUPPLY

METALMASTER machines are supplied wired ready to run. Check the specification plate on the machine to confirm the correct voltage of the power supply.

The machine must be connected by a qualified and licensed electrician. Warranty could be void if it is found that the connection was not carried out by a qualified electrician.

Once connected, check the up and down movement of the back roller (Fig.3.4) by depressing buttons 6 or 7. (Fig.3.3) The roller needs to travel in the same direction as the symbol on the button depressed.

If the direction is incorrect, isolate the machine and make changes to the wiring

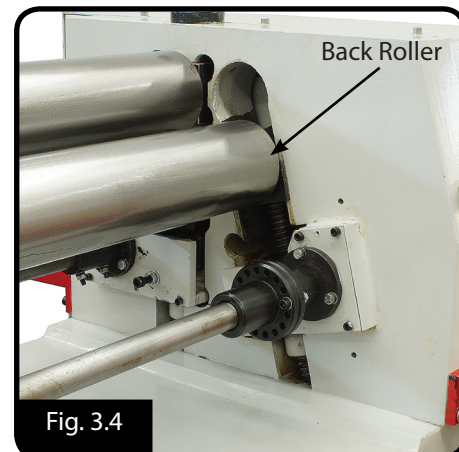
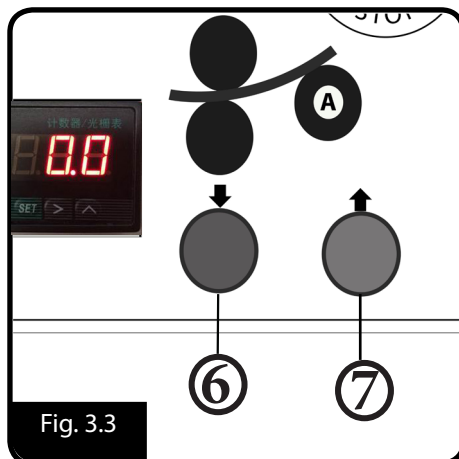



---

## OPERATION MANUAL

---

### 4. COMMISSIONING

#### 4.1. PREPARATION OF THE MACHINE.

- Remove all wrapping and packing grease from the machine.
- Check the machine for loose bolts. Tighten as required.
- Grease all grease nipples.
- Start motor and test Emergency stop operation
- Inform your service provider of any damage or faults with the machine.

#### 4.2. COMMISSIONING CHECK LIST.

Before starting the machine the following checks must be carried out.

- Installation and machine preparation has been performed according to the manuals instructions.
- All grease nipple points have been lubricated.
- Electrical earth fitted and power circuits, switches, and foot-pedal checked.
- Check power connections and any damage to wiring.
- Safety guards have been fitted securely
- Check motor rotation.
- Test Emergency stop to ensure it is operating correctly.
- Test Emergency wire stop to ensure it is operating correctly.
- Test controller operation.
- Test all mechanical operations on the machine.
- Test roll material and check quality of the rolling.
- Tools, equipment and personnel are clear of the machine.
- Operation Manual on how to operate the machine has been read.



**OPERATION MANUAL**

**5. MACHINE OPERATION**

**5.1 START UP**

- a. Check that the electrical supply has been connected.
- b. Check that the Emergency safety wire has been reset
- c. Ensure that the emergency stop button is in the released position.
- d. Ensure the isolating switch is on and power light is illuminated
- e. Press the start button to commence operation (Fig. 5.3)

**5.2 ROLLING**

**Before Operating**

- 1. Clean the material and the rolls of dust and grease
- 2. Make sure there are no chips or flame cutting left-overs on the edge of the material
- 3. Note that if the material has been flame cut the edges will be harder
- 4. Always work in the centre of the rolls

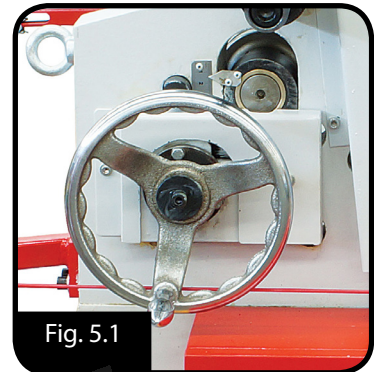

Fig. 5.1

**Rolling**

- a. Place the steel plate in the machine and adjust up the clamping roller using the hand wheel (Fig.5.1)to suit the plate thickness.
- b. Once the steel plate is in position for rolling then the depress the pedal (Fig5.2) to move the plate in the direction required.
- d. Do not roll material which has been welded or deformed.

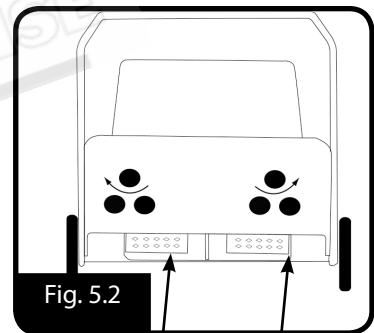

Fig. 5.2

- ① Key Isolation Switch
- ② Illuminated Start Button
- ③ Power Lamp
- ④ Emergency Stop
- ⑤ Digital Display
- ⑥ Bending Roller Down
- ⑦ Bending Roller Up
- ⑧ Roll Forward
- ⑨ Roll Reverse

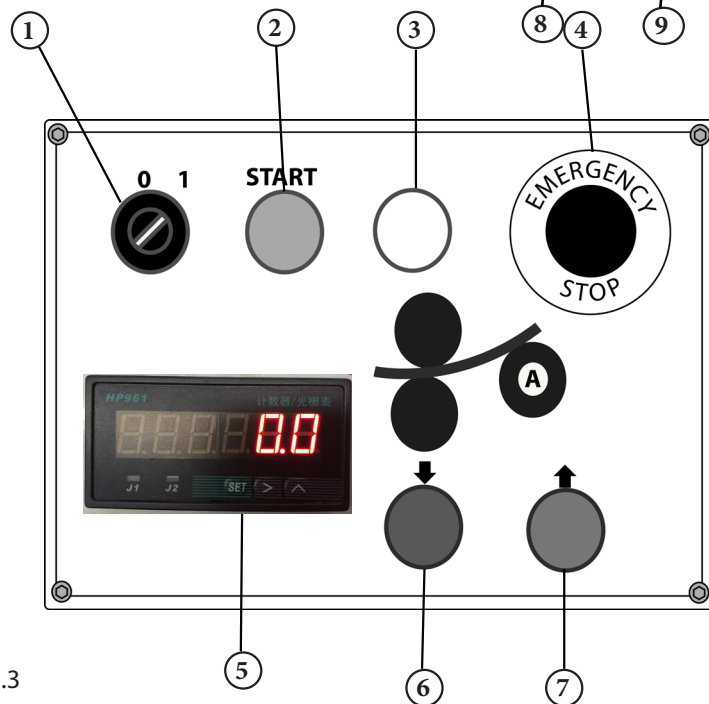

Fig 5.3

### 5.3 RELEASING THE SWINGING ROLLER

The material once rolled will need to be removed from the rolls. To do this one of the rollers can be released at one end and the other end swing away from the machine.

The picture in Fig. 5.4 shows the swinging roller in the locked position.

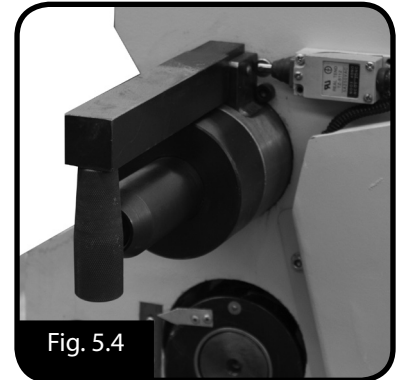

Fig. 5.4

To release the swinging roller raise the locking handle to the vertical position as in Fig. 5.5

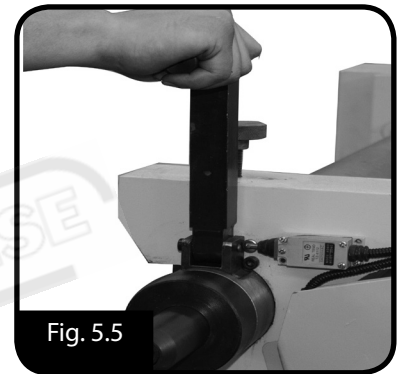

Fig. 5.5

Rotate the lever towards the front of the machine and pull the roller out of its cradle as in Fig. 5.6



Fig. 5.6

Reverse the procedure to replace and lock the roller ready for use. Fig. 5.7

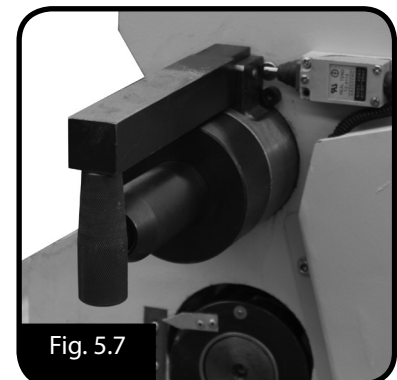

Fig. 5.7

#### 5.4 RESETTING THE ZERO POSITION

If the zero position is lost the bottom roller may not be able to travel to the maximum opening capacity

To set zero on the counter press arrow up (A in Fig.5.8) once. This will set the zero limit position and J2 will be illuminated. Bending roller cannot be driven down past zero.

To reset the zero position, press and hold arrow up (A in Fig.5.8). This will disarm bottom limit so the bending roll can be driven down past zero. The bending roller can now be driven down until the safety limit switch is activated.



Fig. 5.8

#### 5.5 RESET EMERGENCY WIRE SAFETY STOP

This Metalmaster Rolling machine is fitted with a safety Emergency Stop in the form of a red wire that is around the machine. (Fig. 5.9) Pressing against this wire with any part of your body will cut the power to the machine. Safety signs have been placed around the machine to remind the operator of this Emergency Stop. (Fig. 5.10)



Fig. 5.9

Fig. 5.10

**EMERGENCY STOP,  
PRESS WIRE AGAINST MACHINE**

Once the wire has been pressed the emergency switch needs to be reset. To do this the pin on the Emergency Safety micro switch needs to be raised. (See Fig 5.11.)



Fig. 5.11

**METALMASTER****OPERATION MANUAL****6. MAINTAINANCE****6.1 LUBRICATION POINTS**

The machine needs to be lubricated with 30W oil.

Please see the daily lubrication points below. (Fig.6.1)



Fig. 6.1

## 6.2 ADJUSTING THE SAFETY WIRE SWITCH

The Emergency Safety Stop has been set by the factory but the wire may need to be re-tensioned at some time during the life of the machine. Below is the procedure for setting the micro switch that operates the Emergency Safety Stop wire.

### Step 1.

Locate the micro switch and check the shaft of the switch for the position of the black ring on the shaft. (Fig. 6.2)

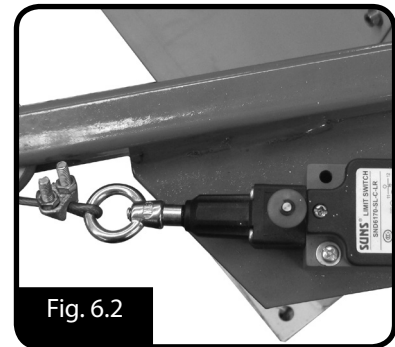

Fig. 6.2

### Step 2.

The correct position of the black ring on the shaft should be level with the end of the shaft housing. Fig. 6.3

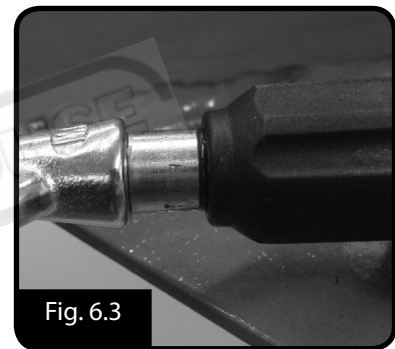

Fig. 6.3

### Step 3.

In the picture shown as Fig.6.4 the black ring has been pulled past the end of the shaft housing indicating that the wire has been tensioned too tight.

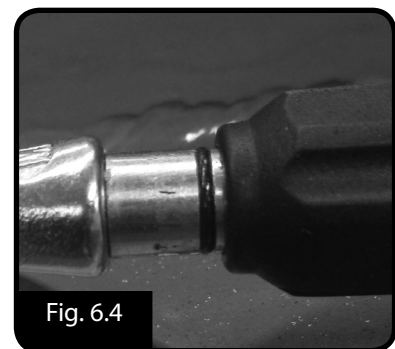

Fig. 6.4

### Step 4.

Loosen and adjust the turnbuckle until the black ring on the shaft is level with the end of the shaft housing (Fig. 6.5)

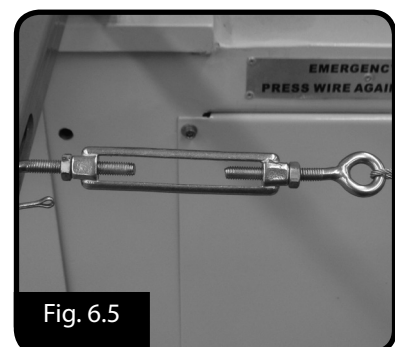

Fig. 6.5





## OPERATION MANUAL

### 6.3 ADJUSTING BENDING ROLL PARALLELISM.

If the finished work piece has not rolled parallel then adjustment will need to be made to bring the bending roller parallel to the pinch roller. The following procedure allows for this change.

#### STEP 1.

Locate the shaft that lowers and raises the bending roll on the front of the machine.

(See Fig.6.6)

Mounted on the shaft is a coupling with multiple holes.



Fig. 6.6

#### Step 2.

To adjust, remove the bolt and rotate the coupling until the travel of the bending roll is parallel with the pinch roller. (Fig. 6.7). Once parallel then insert the bolt and tighten.



Fig. 6.7



## OPERATION MANUAL

### 6.3 TROUBLESHOOTING

PROBLEM	POSSIBLE CAUSES	CORRECTION
Machine will not start	1. Emergency Stop depressed 2. Emergency Wire switch tripped 3. Electrical fault	Twist red stop button and reset the emergency switch  Reset the Emergency wire stop (see page 14)  Contact electrician
Bending roller will not travel down	ZERO not set in the bottom limit.	Zero needs to be reset. (See page 14)
Not rolling parallel	Bending roll not parallel with pinch roll	Make adjustment to the drive shaft coupling (See page 17)



---

## OPERATION MANUAL

---

# SPARE PARTS SECTION

The following section covers the spare parts diagrams and lists that were current at the time this manual was originally printed. Due to continuous improvements of the machine, changes may be made at any time without notification.

### HOW TO ORDER SPARE PARTS

1. Have your machines **model number, serial number & date of manufacture** on hand, these can be found on the specification plate mounted on the machine
2. A scanned copy of your parts list/diagram with required spare part/s identified
3. Go to [www.machineryhouse.com.au/contactus](http://www.machineryhouse.com.au/contactus) and fill out the enquiry form attaching a copy of scanned parts list.

### CONTENTS

A. Electrical Circuit Diagram.....	20
B. Spare Parts Diagram.....	21
Spare Parts List.....	22
Risk Assesment.....	24



# OPERATION MANUAL

## A. ELECTRICAL CIRCUIT DIAGRAM

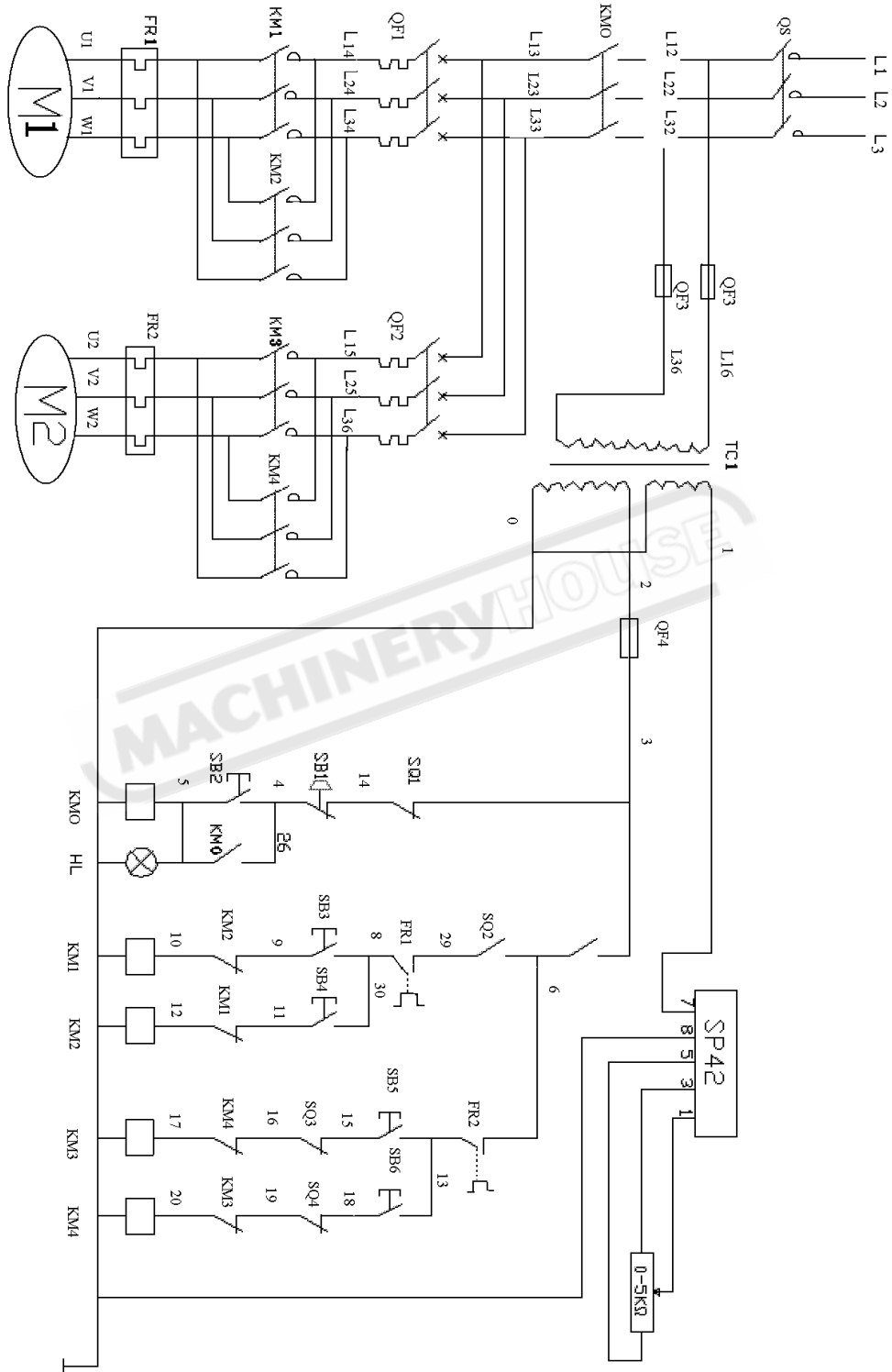



# OPERATION MANUAL

## B. SPARE PARTS DIAGRAM

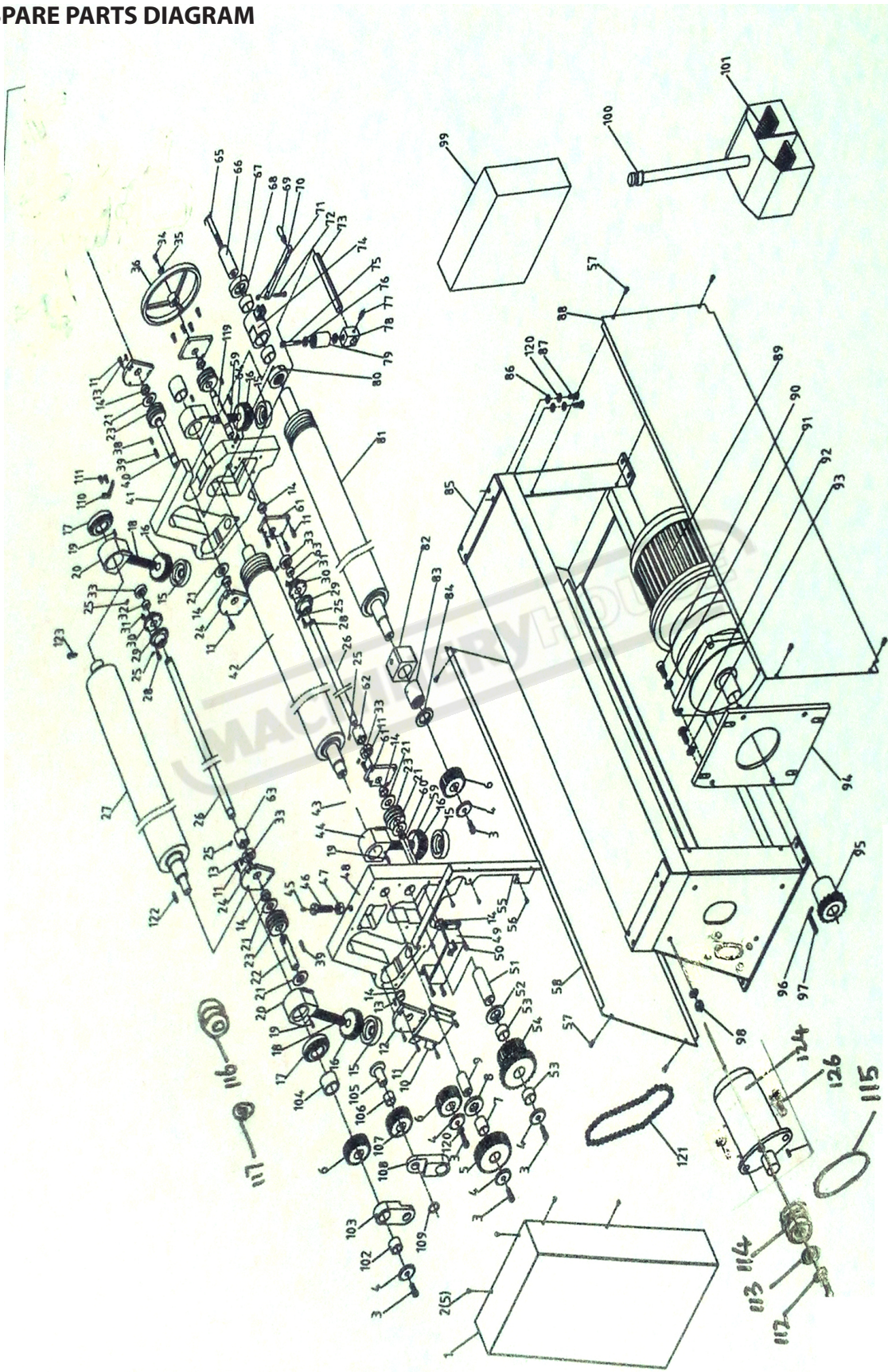



## OPERATION MANUAL

### SPARE PARTS LIST

Part #	Description	Q'ty	Part #	Description	Q'ty
1	Protecting Cover	1	40	Worm Shaft	1
2	Hex Bolt M6X10	5	41	Right frame	1
3	Bolt M12X30	5	42	Lower roller	1
4	Mat	3	43	bushing	2
5	Big gear	1	44	Adjusting block	2
6	Small gear	3	45	Oli cup	1
7	Bushing	1	46	Bolt	1
8	Washer	1	47	Nut M20	1
9	Shaft	1	48	Left frame	1
10	Block plate	1	49	Supporting plate	1
11	Hex Bolt M6X25	40	50	Hex Bolt M8X25	4
12	fixed plate	1	51	Shaft	1
13	Spring pin	2	52	Washer	1
14	Bushing	8	53	Bushing	2
15	Supporting bushing	3	54	Chain wheel	1
16	Worm wheel	3	55	Connecting plate	1
17	Bearing	2	56	Bolt M6X12	9
18	Screw rod	2	57	Bolt M8X16	8
19	Locking bolt M6X16	4	58	Cover plate	1
20	Adjusting block	2	59	Small screw rod	2
21	Washer	8	60	Connecting shaft	1
22	Worm shaft	1	61	Block plate	2
23	Worm shaft	4	62	Connecting bushing	2
24	Block Plate	2	63	Bushing	1
25	Hex bolt M6x16	8	64	Locking bolt M10X30	1
26	Connecting shaft	2	65	Hex bolt M16X130	1
27	Back roll	1	66	Handle	1
28	Key 6x25	4	67	Connecting bushing	1
29	Connecting bushing	2	68	Bushing	2
30	Connecting bushing	2	69	Swivel handle	1
31	Locking Nut M6x16	8	70	Pole of Handle	1
32	Spring washer	2	71	Locking Nut M8	1
33	Connecting bushing	3	72	Hex bolt M8X45	1
34	Hex Bolt M8X20	9	73	Shaft	1
35	Sleeve	1	74	Locking bushing	1
36	Handle wheel	1	75	Hex bolt M12X50	1
37	Hex bolt M8x30	4	76	Bearing	2
38	Key 8x25	2	77	Hex bolt M10X16	1
39	Key 8x45	2	78	Sliding block	1



## OPERATION MANUAL

### PARTS LIST

Part #	Description	Q'ty	Part #	Description	Q'ty
79	Limited block	1	116	Big pulley	1
80	Sliding sleeve	1	117	washer	1
81	Upper roller	1	118	Locking bolt M6x8	2
82	Adjusting block	1	119	Worm shaft	1
83	Sleeve	1	120	Spring washer	8
84	Mat	1	121	Chain	1
85	stand	1	122	Key	3
86	Washer	8	123	Oil cup	1
87	Bolt M12X35	8	124	Elevating Motor	1
88	Block plate	1	125	Key 6x20	1
89	motor	1	126	Hex Bolt M10x50	4
90	Hex bolt M16X35	4	127	Washer 10	4
91	Spring washer 16	4	128	Nut M10	4
92	Bolt M16X40	4			
93	Washer 16	8			
94	Plate for motor	1			
95	Small chain wheel	1			
96	Locking Bolt M8X16	2			
97	Key	1			
98	Nut M16	4			
99	Electrical box	1			
100	Control box	1			
101	Foot pedal	1			
102	Bearing	1			
103	Connecting plate	1			
104	Spacer	1			
105	Small shaft	1			
106	Bushing	1			
107	Gear	1			
108	Connecting plate	1			
109	Spacer	1			
110	Switch Bracket	1			
111	Hex screw M5x12	2			
112	Hex screw M6x25	2			
113	washer	1			
114	Small pulley	2			
115	V-belt	2			



# WARNING

## General Machinery Safety Instructions

---

Machinery House  
requires you to read this entire Manual before using this machine.

- 1. Read the entire Manual before starting machinery.** Machinery may cause serious injury if not correctly used.
- 2. Always use correct hearing protection when operating machinery.** Machinery noise may cause permanent hearing damage.
- 3. Machinery must never be used when tired, or under the influence of drugs or alcohol.** When running machinery you must be alert at all times.
- 4. Wear correct Clothing.** At all times remove all loose clothing, necklaces, rings, jewelry, etc. Long hair must be contained in a hair net. Non-slip protective footwear must be worn.
- 5. Always wear correct respirators around fumes or dust when operating machinery.** Machinery fumes & dust can cause serious respiratory illness. Dust extractors must be used where applicable.
- 6. Always wear correct safety glasses.** When machining you must use the correct eye protection to prevent injuring your eyes.
- 7. Keep work clean and make sure you have good lighting.** Cluttered and dark shadows may cause accidents.
- 8. Personnel must be properly trained or well supervised when operating machinery.** Make sure you have clear and safe understanding of the machine you are operating.
- 9. Keep children and visitors away.** Make sure children and visitors are at a safe distance for you work area.
- 10. Keep your workshop childproof.** Use padlocks, Turn off master power switches and remove start switch keys.
- 11. Never leave machine unattended.** Turn power off and wait till machine has come to a complete stop before leaving the machine unattended.
- 12. Make a safe working environment.** Do not use machine in a damp, wet area, or where flammable or noxious fumes may exist.
- 13. Disconnect main power before service machine.** Make sure power switch is in the off position before re-connecting.
- 14. Use correct amperage extension cords.** Undersized extension cords overheat and lose power. Replace extension cords if they become damaged.
- 15. Keep machine well maintained.** Keep blades sharp and clean for best and safest performance. Follow instructions when lubricating and changing accessories.
- 16. Keep machine well guarded.** Make sure guards on machine are in place and are all working correctly.
- 17. Do not overreach.** Keep proper footing and balance at all times.
- 18. Secure workpiece.** Use clamps or a vice to hold the workpiece where practical. Keeping the workpiece secure will free up your hand to operate the machine and will protect hand from injury.
- 19. Check machine over before operating.** Check machine for damaged parts, loose bolts, Keys and wrenches left on machine and any other conditions that may effect the machines operation. Repair and replace damaged parts.
- 20. Use recommended accessories.** Refer to instruction manual or ask correct service officer when using accessories. The use of improper accessories may cause the risk of injury.
- 21. Do not force machinery.** Work at the speed and capacity at which the machine or accessory was designed.
- 22. Use correct lifting practice.** Always use the correct lifting methods when using machinery. Incorrect lifting methods can cause serious injury.
- 23. Lock mobile bases.** Make sure any mobile bases are locked before using machine.
- 24. Allergic reactions.** Certain metal shavings and cutting fluids may cause an allergic reaction in people and animals, especially when cutting as the fumes can be inhaled. Make sure you know what type of metal and cutting fluid you will be exposed to and how to avoid contamination.
- 25. Call for help.** If at any time you experience difficulties, stop the machine and call you nearest branch service department for help.



# WARNING

## Motorised Sheetmetal Rolling Machine Safety Instructions

---

Machinery House  
requires you to read this entire Manual before using this machine.

- 1. Maintenance.** Make sure the Rolling machine is turned off and disconnect from the main power supply and make sure all moving parts have come to a complete stop before any inspection, adjustment or maintenance is carried out.
- 2. Rolling machine Condition.** Rolling machine must be maintained for a proper working condition. Never operate a Rolling machine that has damaged or worn parts. Scheduled routine maintenance should be performed on a scheduled basis.
- 3. Roll Condition.** Never operate a Rolling machine with a damaged or badly worn Rolls. Replace if required. Rolls should never be greased or lubricated as rolls will slip the material and will not bend.
- 4. Roll Direction.** Be aware of the correct Rotational axis of the motor when a qualified electrician connects the machine.
- 5. Hand Hazard.** Keep hands and fingers clear from moving parts. Serious injury can occur if hand or finger tips get pinched by rolls and can be dragged into machine.
- 6. Personal Protection.** Gloves, safety glasses and safety hat are recommended during operation.
- 7. Avoiding Entanglement.** Rolling machine guards must be used at all times. Tie up long hair and use the correct hair nets to avoid any entanglement with the Rolling machine moving parts.
- 8. Understand the machines controls.** Make sure you understand the use and operation of all controls.
- 9. Trained Operator.** This machine must be operated by authorized and trained personnel.
- 10. Power outage.** In the event of a power failure during use of the machine, turn off all switches to avoid possible sudden start up once power is restored.
- 11. Work area hazards.** Keep the area around the Rolling machine clean from oil, tools, chips. Pay attention to other persons in the area and know what is going on around the area to ensure unintended accidents.
- 12. Guards.** Do not operate Rolling machine without the correct guards in place. Necessary guards protect you from injuries by worm-type gearbox and other gears. The only other area which needs to be carefully monitored during use is the rotational area of the rolls.
- 13. Material condition.** Material must be clean out of oil and dry. Oily material can slip and will not bend.
- 14. Material hardness.** Make sure your hardness is the same throughout the material, we recommend that you use certified material. Never bend hard steel, glass or fragile material on this machine.
- 15. Feeding material.** Making a tight bend in one pass is not possible. So you need several passes before you can achieve a certain radius. Tighter curves and full radius always need more passes.
- 16. Stopping the Rolls.** Do not stop or slow the rolls with your hand or workpiece. Allow the Rolling machine to stop on its own.
- 17. Emergency stop.** Use the emergency stop button in case of any emergency.
- 18. Hearing protection and hazards.** Always wear hearing protection as noise generated from machine and workpiece can cause permanent hearing loss over time.
- 19. Call for help.** If at any time you experience difficulties, stop the machine and call your nearest branch service department for help.

## PLANT SAFETY PROGRAM

### **NEW MACHINERY HAZARD IDENTIFICATION, ASSESSMENT & CONTROL**

### **Motorised Sheetmetal Rolling Machine**

Developed in Co-operation Between A.W.I.S.A and Australia Chamber of Manufactures  
This program is based upon the Safe Work Australia, Code of Practice - Managing Risks of Plant in the Workplace ( WHSA 2011 No10 )

Item No.	Hazard Identification	Hazard Assessment	Risk Control Strategies <small>(Recommended for Purchase / Buyer / User)</small>
A	ENTANGLEMENT CRUSHING	HIGH LOW	Eliminate, avoid loose clothing / Long hair etc. Secure & support work material. Ensure machine is bolted down.
C	CUTTING, STABBING, PUNCTURING.	MEDIUM	Isolate power to machine prior to any checks or maintenance being carried out. Do not adjust or clean until the machine has fully stopped. Wear gloves to prevent cuts from material.
D	SHEARING	MEDIUM	Isolate power to machine when checks or maintenance is being carried out. Make sure all guards are secured shut when machine is on. Hands should be kept clear of moving parts such as rolls etc.
F	STRIKING	MEDIUM	Ensure area is kept clear of material being rolled.
H	ELECTRICAL	MEDIUM	All electrical enclosures should only be opened with a tool that is not to be kept with the machine. Machine should be installed & checked by a Licensed Electrician.
O	OTHER HAZARDS, NOISE.	LOW	Wear hearing protection as required.
Plant Safety Program to be read in conjunction with manufactures instructions			



[www.machineryhouse.com.au](http://www.machineryhouse.com.au)



[www.machineryhouse.co.nz](http://www.machineryhouse.co.nz)

Authorised and signed by:  
Safety officer:

Manager:

*[Signature]*

Revised Date: 12th March 2012